

Kwalu Features

Kwalu Fusion

- Kwalu's proprietary polymer material
- Non-coated
- Routed edge seam

Moisture Impervious

- Our Kwalu material is smooth, non-porous, and liquid impervious

Proprietary Maintenance-Free Finish

- Chemical, impact, ink, and scratch resistant
- 100% free of short-lived catalytic lacquers, polyurethane varnishes and delicate wood veneers
- Look of wood's enduring beauty, without undertaking its costly setbacks

Easy to Clean

- Withstands rigorous cleaning regime
- 100% bleach cleanable
- Provide long term cleanability
- Survives All EPA's Cleaning-Disinfectant Agents
- Survives Clorox's Healthcare Portfolio of Cleaning-Disinfectant Products

24/7 10-Year Performance Warranty on Kwalu-made Panels

- Kwalu's warranty is to term, not pro-rated
- Guaranteeing both the furniture construction and Kwalu finish
- For full details of warranty offered, including any bought-out items, please refer to the Terms and Conditions of Sale <https://www.kwalu.com/sales-terms-conditions/>

Eco-friendly

- LEED credits available for "Material + Resources" and "Indoor Environmental Air Quality"
- Made in North America
- CARB Compliant

Atlanta Collection Features

Tops

- Edge Type: Waterfall profile
- Edge Thickness: 3/8"
- Top Overhang: - Sides: 1/8" - Front: 1/4" - Back: 1/16"
- Corner Radius: 1/2"

Doors

- Door Style: Inset
- Door Hinge: 100° self-closing Euro hinge
- Edge Banding thickness: 1/16"

Drawers

- Drawer Style: Inset
- Drawer Slide: 100lb. bottom mounted Euro epoxy coated nylon rollers
- Drawer Box Sides and Back: 1/2" board
- Drawer Bottom: 1/4" board
- Drawer construction: 3- piece construction; dowel and mechanical fasteners
- Drawer Pulls: ADA Compliant pulls available
- Edge Thickness: 1/16"

Back Construction

- 1/4" Solid board

Desk Construction

- 3/4" Plywood

Jointing System

- Dowel and mechanical fasteners

Venting

- Venting on back of bedside cabinet with one drawer, one door only

Glides

- Standard Option for most products: Nylon knock-in glides
- Cabinets over 30" wide and/or 48" high: Screw-in levelers

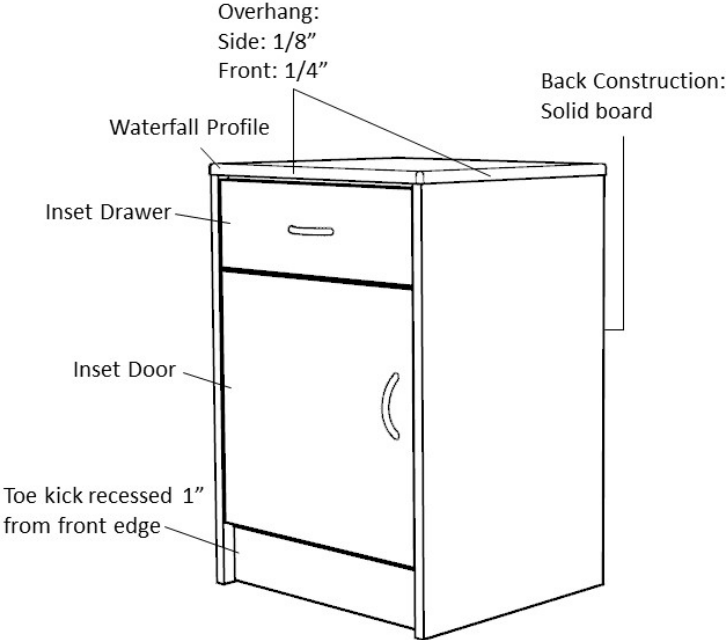

Product Dimensions and Specs

Overall 34.75W 23D 71H

Wt. 233 lbs

Product Statement of Line Images

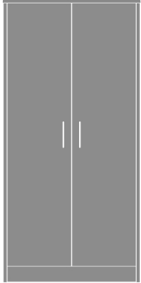

Atlanta Double Wardrobe, No
Drawers, 2 Doors
Moasfadel: ATWR02
34.75W 23D 71H

Product Features



Durable Finish

Kwalu's proprietary finish doesn't have any of the drawbacks of wood. The finish is moisture impervious, easy to clean and maintenance-free.



Wall Mount Hardware

The kit and instructions for wall mounting are included with this product. The wall mount instructions provided must be followed carefully for a secure, durable, and long-lasting solution to ensure the safety of the unit and the user.



Door Hinges

100° self-closing, kitchen-grade Blum® Euro Hinges provide a smooth motion.



Clothes Rod

Standard clothing rod may be attached at ADA height of 48" from the floor.

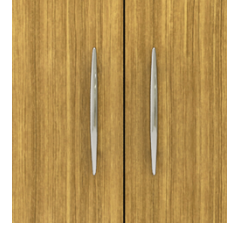

Hardware

Choose from dozens of hardware styles, including ADA compliant options.



Other Wardrobe Styles

Atlanta wardrobes include a number of Single and Double styles.



10 Year Warranty

We offer a 10 Year Performance Warranty on both construction and finish, so the product is guaranteed to stay looking like new for 10 years.

Product Finishes

Casegood Finish



Wood Ash
(Fusion)

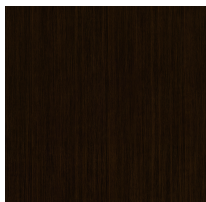

Midnight Oak
(Fusion)

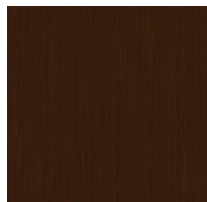

Natural
Mahogany
(Fusion)

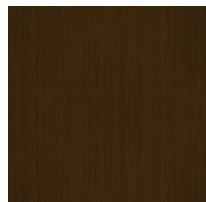

Espresso
(Fusion)

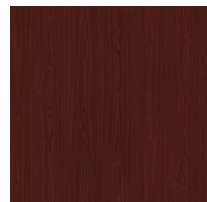

African
Mahogany
(Fusion)

Product Environmental Certifications

